

UL 5 - 12

12V 5AH

STANDBY

Ultracell®

'Quality in Every Language'

Image



Terminal Type

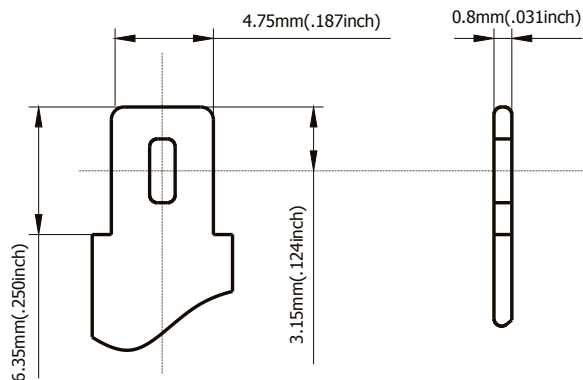

Dimensions

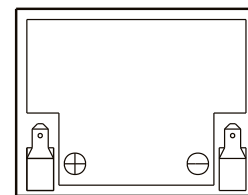
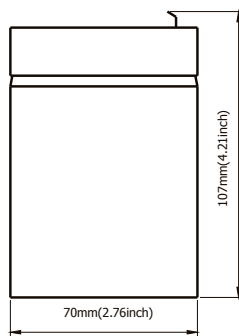
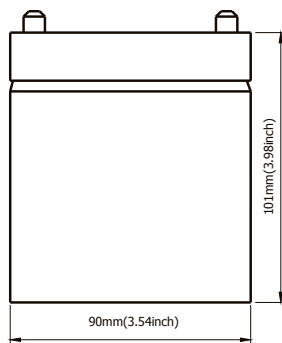

Specifications

Battery Model	UL 5 - 12			
Designed Floating Life	5 Years			
Capacity (25°C)	20HR (0.25A, 1.75V)	10HR (0.475A, 1.75V)	5HR (0.85A, 1.75V)	1HR (3.0A, 1.55V)
	5.0AH	4.75AH	4.25AH	3AH
Dimensions	Length	Width	Height	Total Height
	90mm	70mm	101mm	107mm
Approx. Weight	1.70Kg			
Internal Resistance	Fully Charged at 25°C 0.025 Ohm			
Self Discharge	3% of capacity declined per month at 25°C			
Capacity Affected by Temperature	40°C	25°C	0°C	-15°C
	102%	100%	85%	65%
Charge Voltage (25°C)	Cycle Use		Float Use	
	14.0-15.0V (-24mV/C), max. Current: 1.5A		13.6-13.8V (-18mV/C)	

Construction

Component ——— Raw material
 Positive ——— Lead dioxide
 Negative ——— Lead
 Container ——— ABS (Flame Retardent optional)
 Cover ——— ABS (Flame Retardent optional)

Sealed and maintenance free option

Sealant ——— Epoxy Resin
 Safety Valve ——— EPDR
 Terminal ——— Copper
 Separator ——— Fibre Glass
 Electrolyte ——— Sulphuric acid

Non-spillable construction design



CE 1188



MH 29410

Tel | +44 (0) 151 523 2777
 Fax | +44 (0) 151 523 0855
 E-mail | info@ultracell.co.uk
 Web | www.ultracell.co.uk

Charge Characteristic

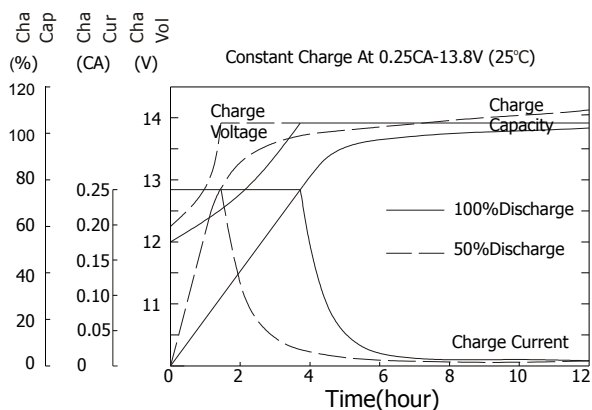

Discharge Characteristic 25°C

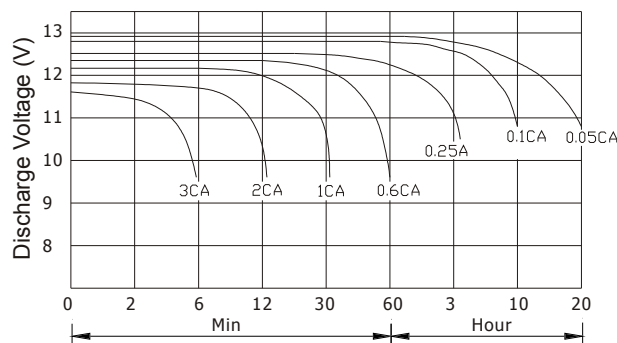

Relationship of OCV and state of charge

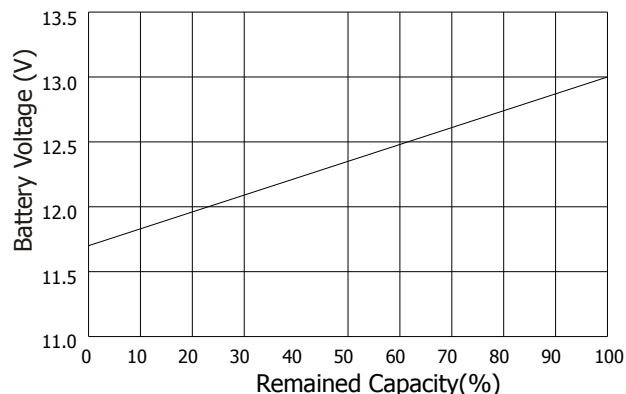

Self Discharge Characteristics

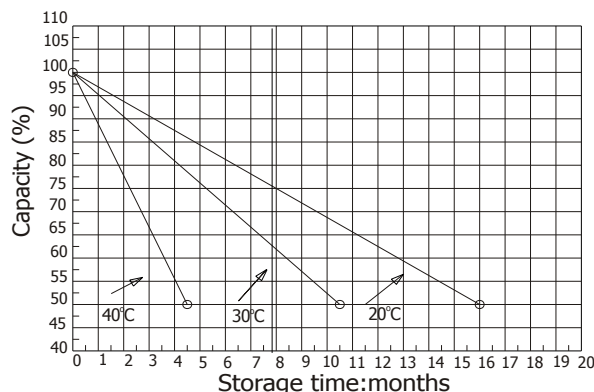

Constant Current Discharge Ratings - amperes at 25°C

F.V / Time	5 MIN	10 MIN	15 MIN	30 MIN	1 HR	3 HR	5 HR	10 HR	20 HR
1.60 V	19.7	12.1	9.17	5.59	3.00	1.56	0.92	0.51	0.28
1.67 V	18.3	11.6	8.89	5.36	2.97	1.32	0.90	0.50	0.27
1.70 V	16.9	11.1	8.61	4.86	2.86	1.25	0.88	0.49	0.27
1.75 V	16.7	10.8	8.33	4.63	2.80	1.22	0.85	0.48	0.26
1.80 V	14.8	10.3	7.57	4.29	2.61	1.19	0.84	0.48	0.26
1.85 V	13.1	9.78	6.78	3.93	2.53	1.17	0.84	0.37	0.26

Constant Power Discharge Ratings - watts at 25°C

F.V / Time	5 MIN	10 MIN	15 MIN	30 MIN	1 HR	3 HR	5 HR	10 HR	20 HR
1.60 V	40.0	26.0	20.0	11.6	6.50	2.53	1.72	0.97	0.51
1.67 V	38.7	25.4	19.7	11.4	6.43	2.52	1.71	0.97	0.51
1.70 V	37.1	25.0	19.2	11.2	6.36	2.50	1.71	0.96	0.50
1.75 V	34.9	24.2	18.6	10.9	6.26	2.48	1.70	0.96	0.50
1.80 V	30.3	22.2	17.8	10.6	6.06	2.43	1.68	0.94	0.49
1.85 V	28.6	20.6	17.0	10.1	5.92	2.39	1.66	0.94	0.49



CE 1188



MH 29410

Tel | +44 (0) 151 523 2777
Fax | +44 (0) 151 523 0855
E-mail | info@ultracell.co.uk
Web | www.ultracell.co.uk